

# Specification

1. Product Type: 5G Antenna
  2. Frequency : 600~6000 MHZ
  3. VSWR: 2.0:1
  4. Cable: RG316/U
  5. Connector: MCX M RA
- ✳️RoHS Compliant

	Connector	Cover	OD	Cable	Frequency	<div style="border: 2px solid black; padding: 5px; display: inline-block;"><b>ROHS</b></div> ISO 9001 ISO 14001
LTE 5G	MCX M RA (Gold)	Black	∅2.6±0.2	RG316/U	600~6000MHz	

Unit packaging sticker



SR : B-107004  
MATERIAL : PC (Black)

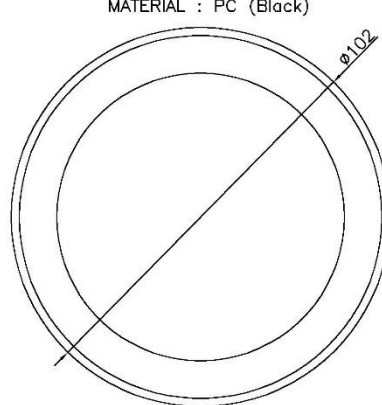

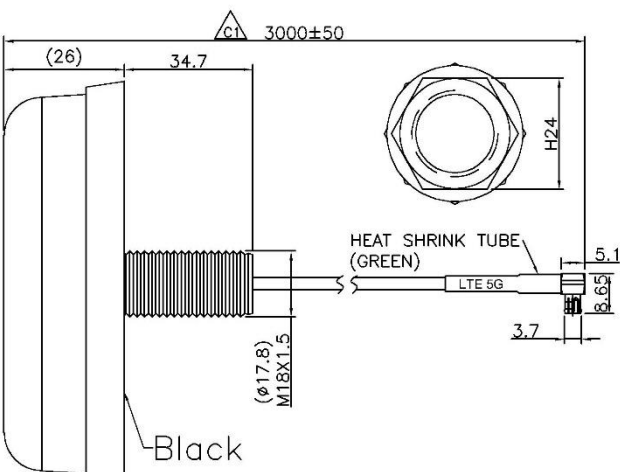

Black

Cable : VW-1/13 mesh  
Low temperature resistance

2022/9/7  Original 2M5 Change 3M		Material:		Treatment:		TRANSVOICE	
2022/7/12  Change Cable VW-1		Drawer	Design	Aprov	Tolerance	Unit: mm	
					X=±0.5 .X=±0.2 .XX=±0.1 .XXX=±0.05	Ver: C	Scale 1:1
NO	DESCRIPTION	MATERIAL / FINISH		Q*TY		Model NO	202-941
Part NO					File NO: QR0402	Drawing NO	100-27001-0219

Frequency (MHz)	Return Loss (dB)	VSWR	Efficiency (%)	Gain (dBi)
600	-11.24	1.73	70.96	2.04
690	-12.52	1.63	44.16	0
824	-16.75	1.29	55.21	3.17
960	-13.83	1.54	54.08	1.32
1710	-19.29	1.24	62.81	4.84
1880	-17.23	1.35	59.84	3.14
2170	-10.13	1.98	25.76	0.87
2400	-11.97	1.67	31.62	2.48
2500	-12.33	1.63	37.76	5.04
2600	-11.13	1.86	33.81	4.14
2700	-15.66	1.39	52.48	5.65
3300	-10.37	1.87	51.76	5.14
3600	-9.85	1.95	58.61	7.67
3800	-12.36	1.67	63.68	7.51
4400	-13.90	1.51	50.93	5.11
5150	-13.43	1.54	45.29	4.19
5500	-13.11	1.57	43.65	3.66
5800	-12.39	1.67	45.19	4.49

# Test Report(Return Loss & VSWR)

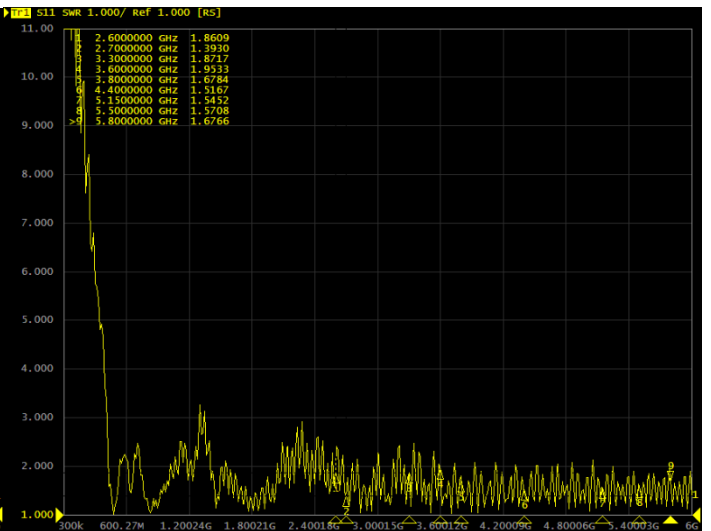
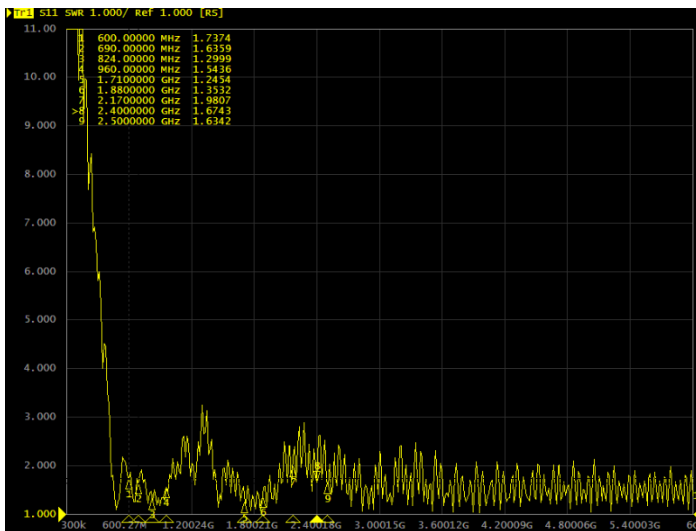
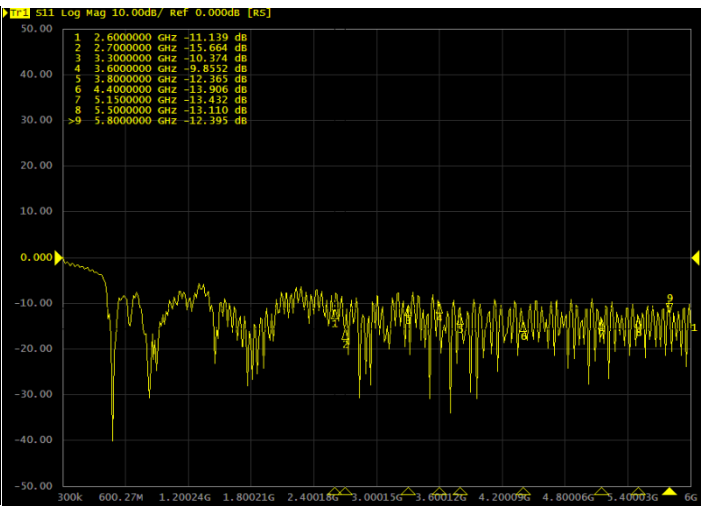
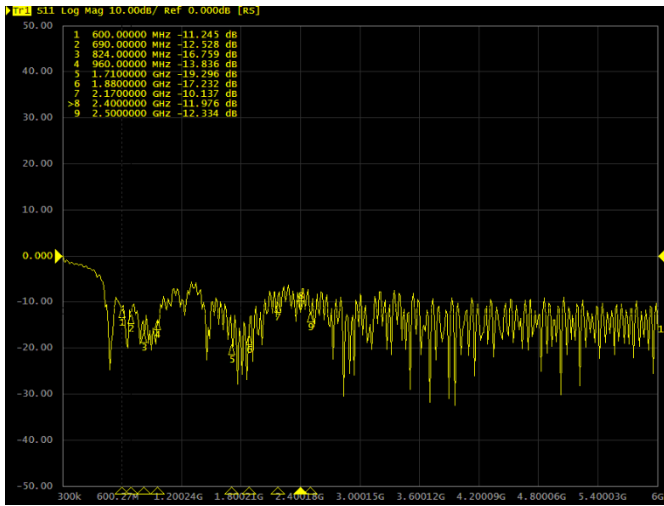

## 3D Test photo

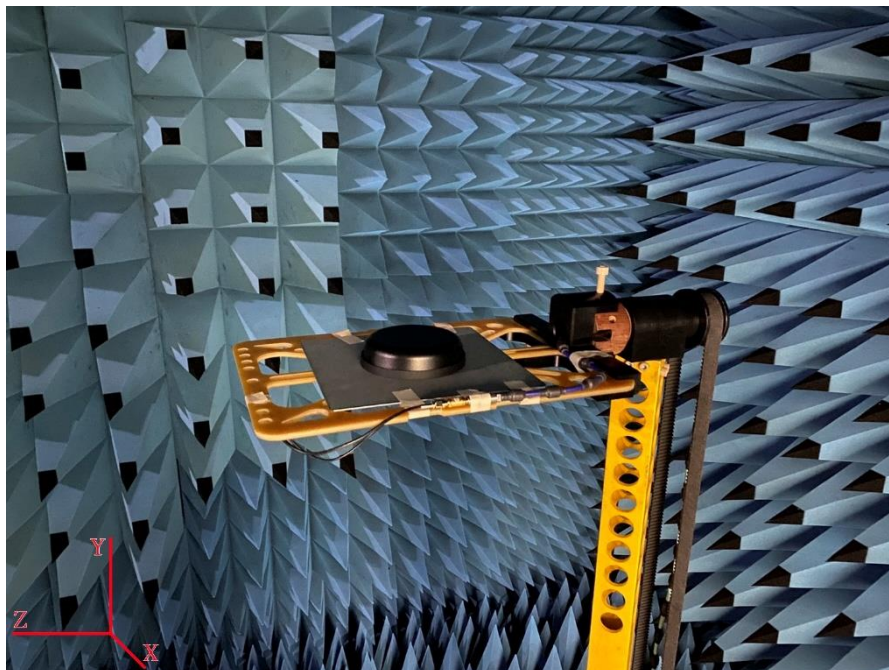

### 3D Test Data

Freq. / Chan.	Color
600MHz	Red
690MHz	Blue
824MHz	Green
960MHz	Magenta
1.71GHz	Cyan
1.88GHz	Yellow
2.17GHz	Black
2.4GHz	Purple
2.5GHz	Dark Blue
2.6GHz	Teal
2.7GHz	Orange
3.3GHz	Light Blue
3.6GHz	Dark Green
3.8GHz	Pink
4.4GHz	Tan
5.15GHz	Brown
5.5GHz	Dark Blue
5.8GHz	Grey

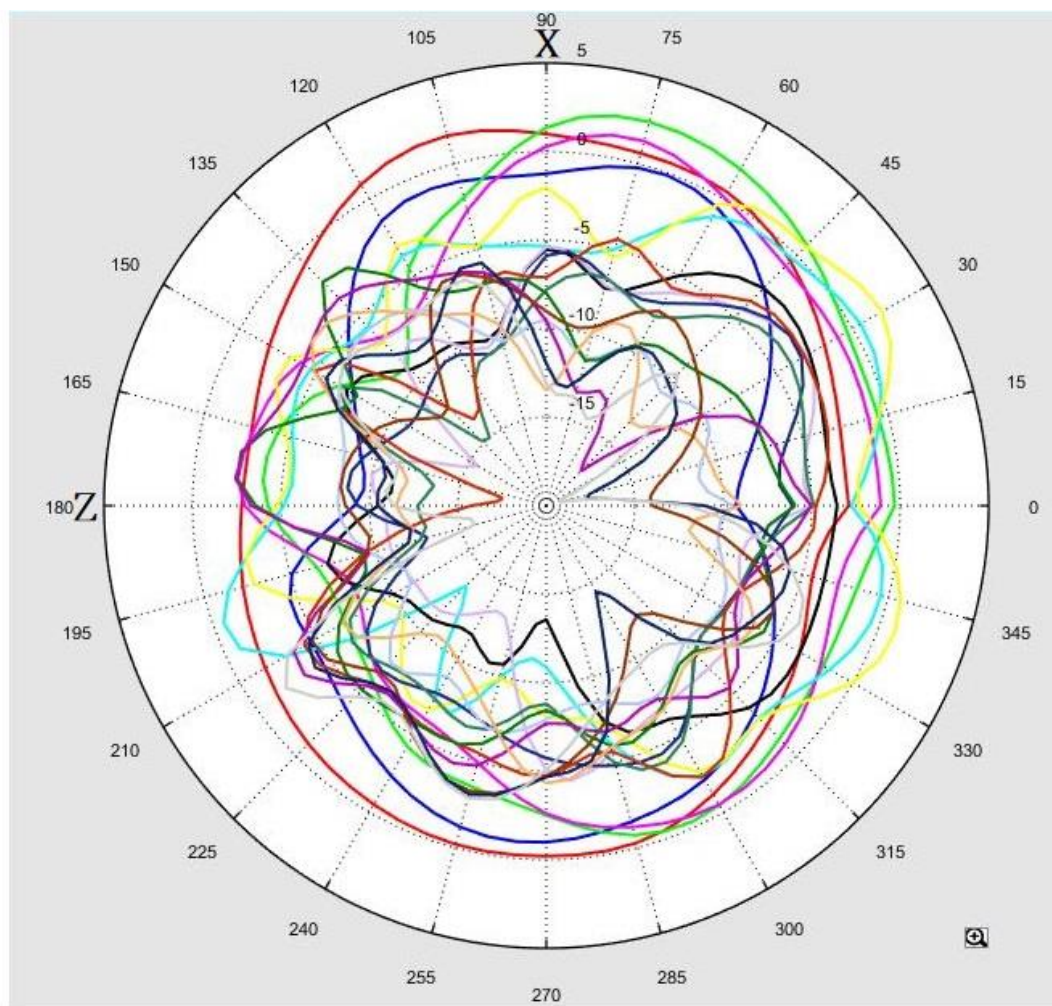

Total\_Efficiency (%)

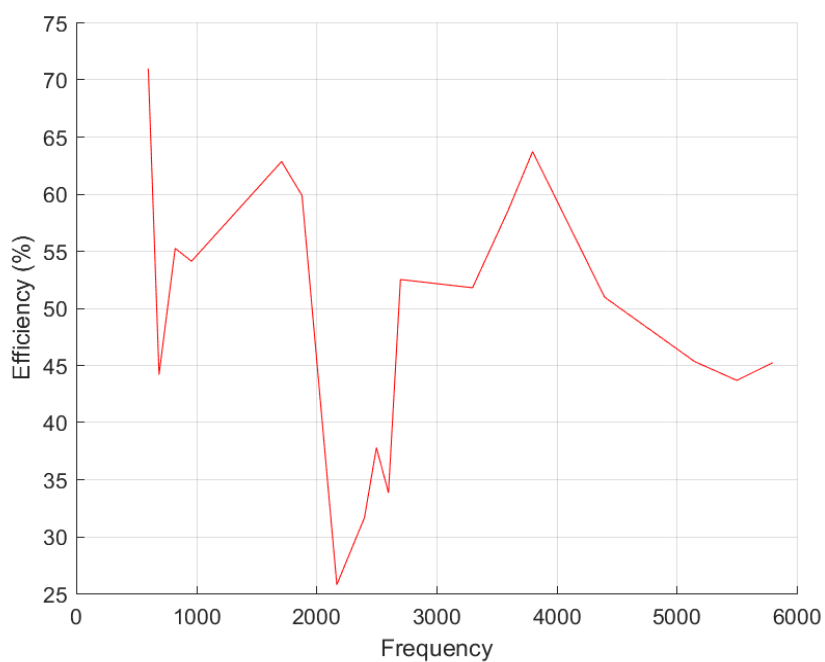

# Total\_Gain (dBi)

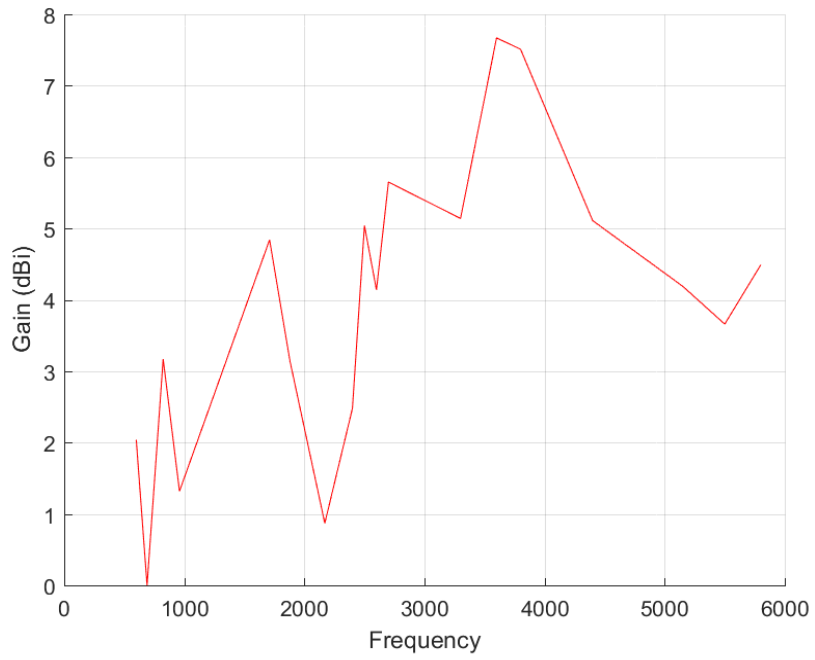

Total\_3D\_Top View\_600MHz

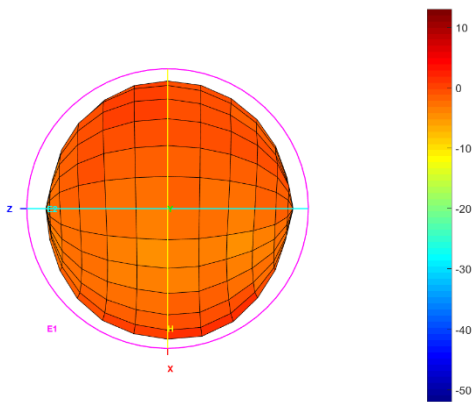

Total\_3D\_Front View\_600MHz

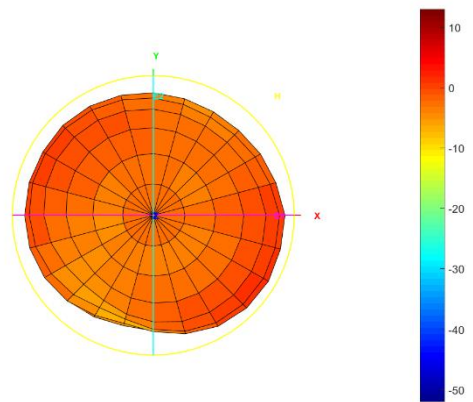

Total\_3D\_Left View\_600MHz

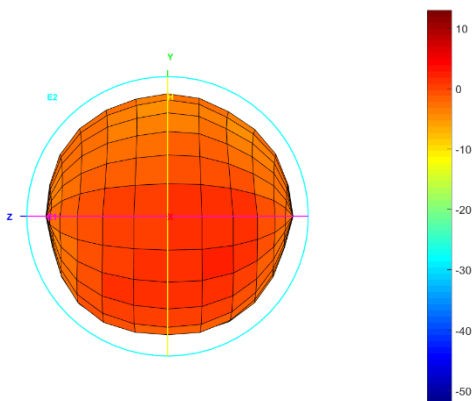

Total\_3D\_Side View 1\_600MHz

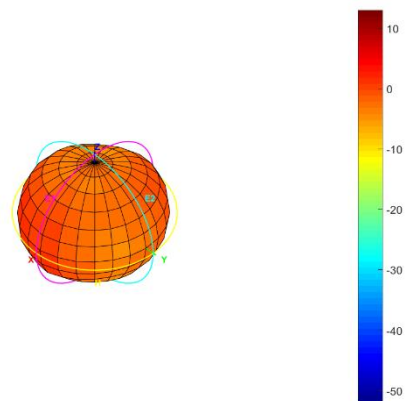

Total\_3D\_Top View\_690MHz

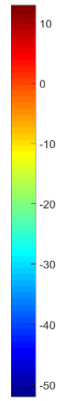
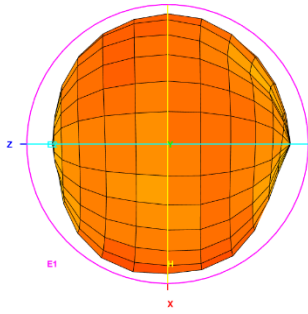

Total\_3D\_Front View\_690MHz

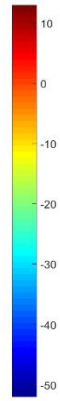
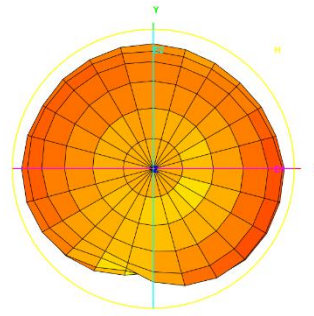

Total\_3D\_Left View\_690MHz

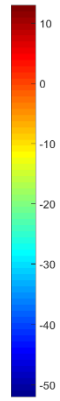
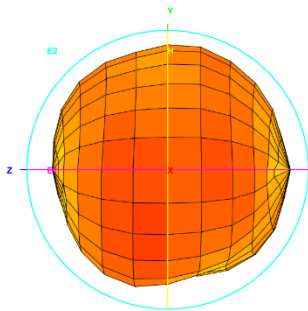

Total\_3D\_Side View 1\_690MHz

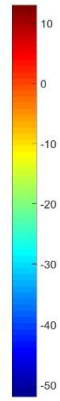
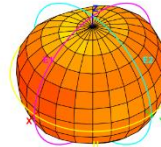

Total\_3D\_Top View\_824MHz

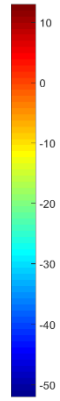
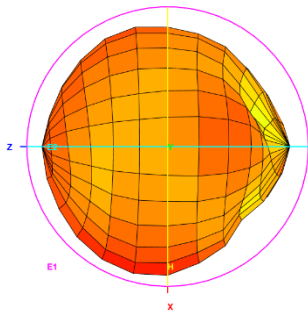

Total\_3D\_Front View\_824MHz

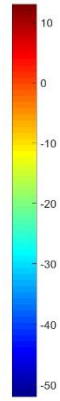
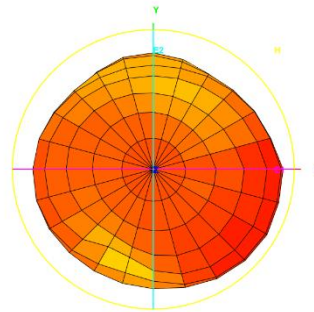

Total\_3D\_Left View\_824MHz

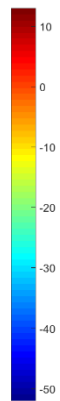
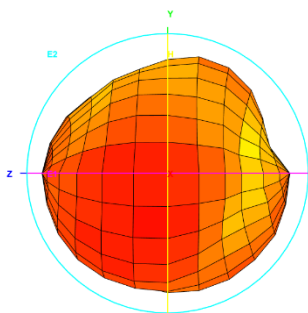

Total\_3D\_Side View 1\_824MHz

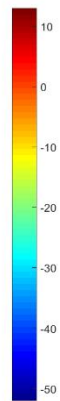
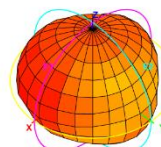

Total\_3D\_Top View\_960MHz

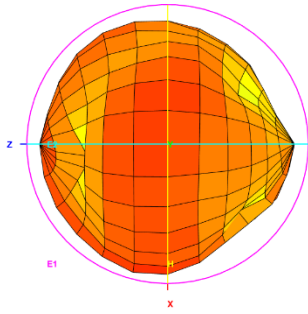

Total\_3D\_Front View\_960MHz

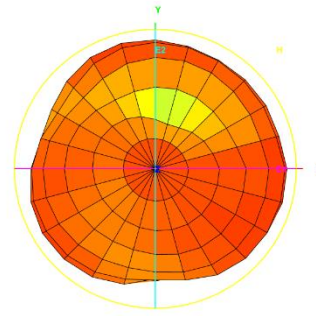

Total\_3D\_Left View\_960MHz

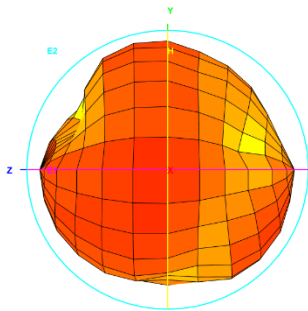

Total\_3D\_Side View\_1\_960MHz

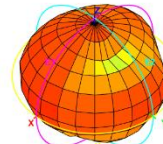

Total\_3D\_Top View\_1.71GHz

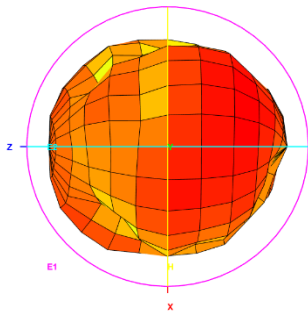

Total\_3D\_Front View\_1.71GHz

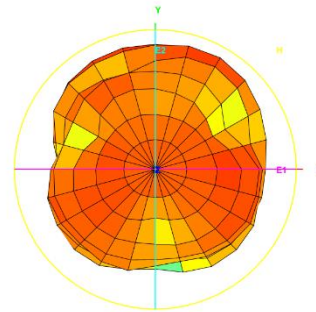

Total\_3D\_Left View\_1.71GHz

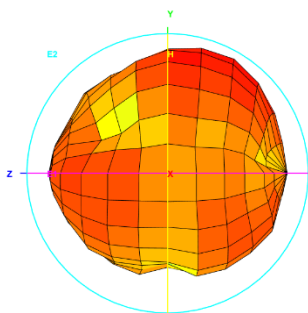

Total\_3D\_Side View\_1\_1.71GHz

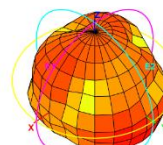

Total\_3D\_Top View\_1.88GHz

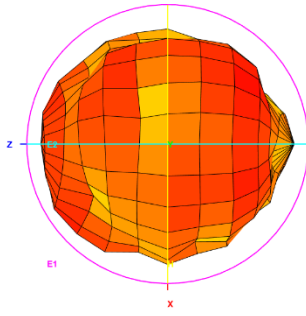

Total\_3D\_Front View\_1.88GHz

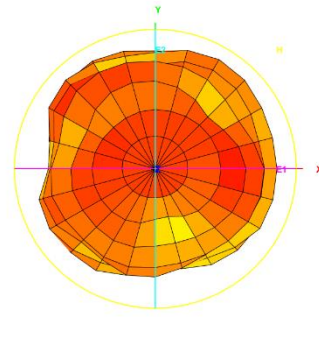

Total\_3D\_Left View\_1.88GHz

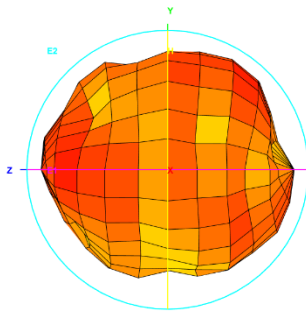

Total\_3D\_Side View 1\_1.88GHz

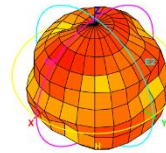

Total\_3D\_Top View\_2.17GHz

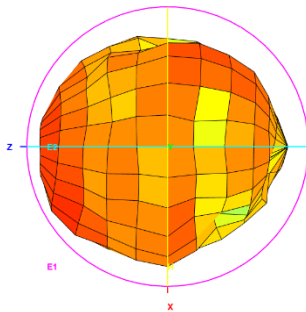

Total\_3D\_Front View\_2.17GHz

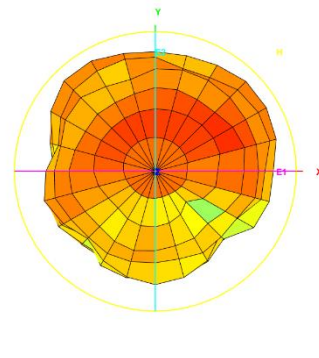

Total\_3D\_Left View\_2.17GHz

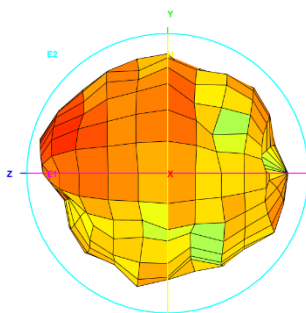

Total\_3D\_Side View 1\_2.17GHz

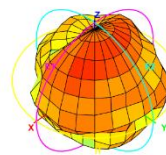



Total\_3D\_Top View\_2.4GHz

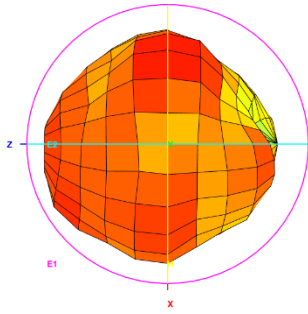

Total\_3D\_Front View\_2.4GHz

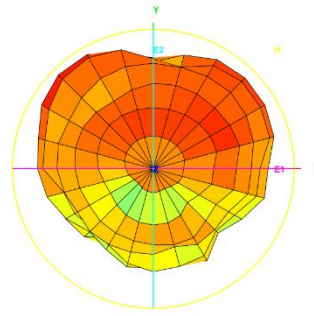

Total\_3D\_Left View\_2.4GHz

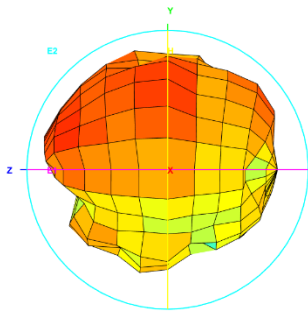

Total\_3D\_Side View 1\_2.4GHz

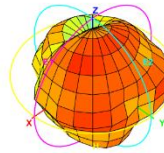

Total\_3D\_Top View\_2.5GHz

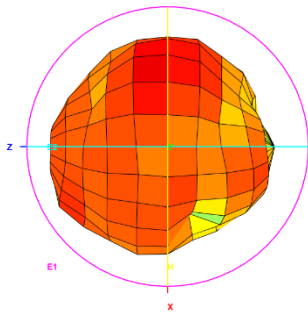

Total\_3D\_Front View\_2.5GHz

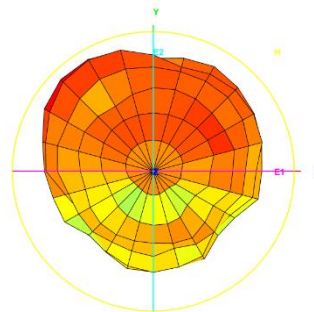

Total\_3D\_Left View\_2.5GHz

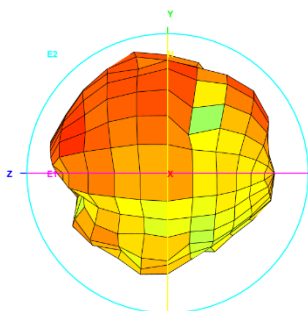

Total\_3D\_Side View 1\_2.5GHz

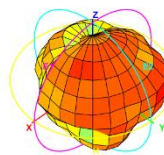

Total\_3D\_Top View\_2.6GHz

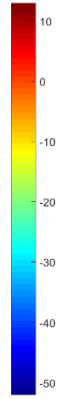
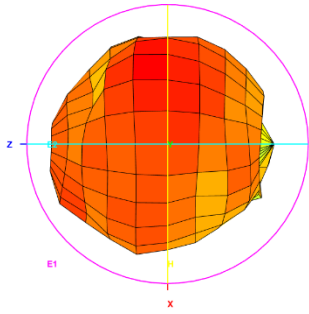

Total\_3D\_Front View\_2.6GHz

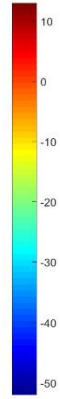
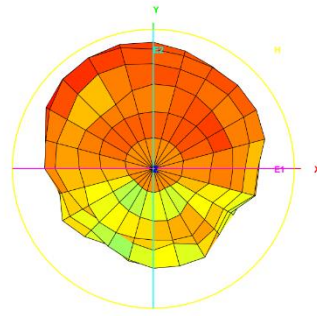

Total\_3D\_Left View\_2.6GHz

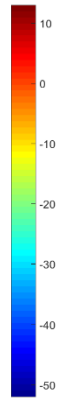
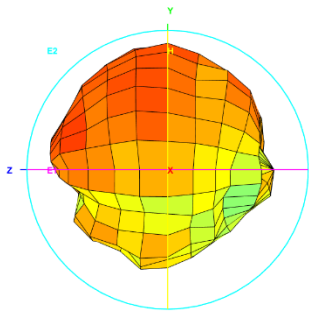

Total\_3D\_Side View 1\_2.6GHz

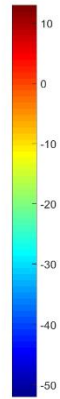
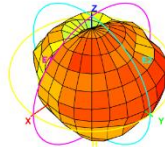

Total\_3D\_Top View\_2.7GHz

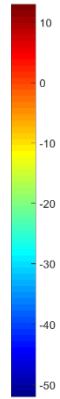
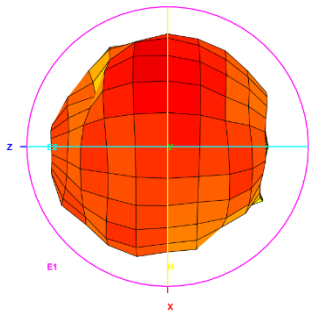

Total\_3D\_Front View\_2.7GHz

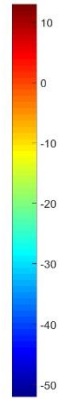
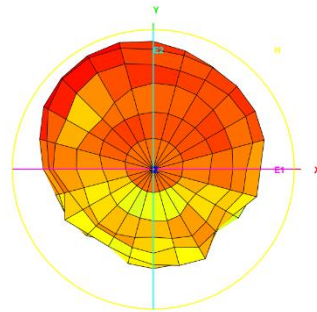

Total\_3D\_Left View\_2.7GHz

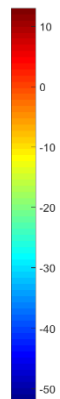
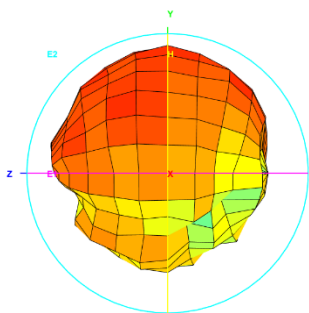

Total\_3D\_Side View 1\_2.7GHz

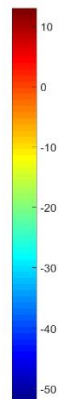
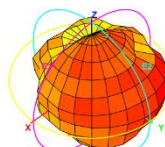

Total\_3D\_Top View\_3.3GHz

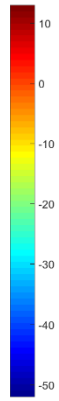
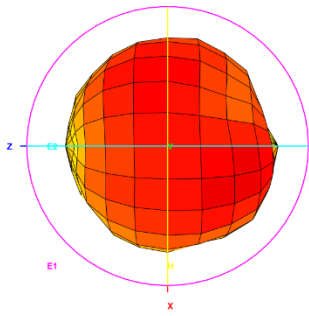

Total\_3D\_Front View\_3.3GHz

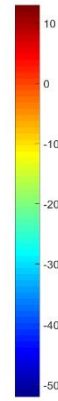
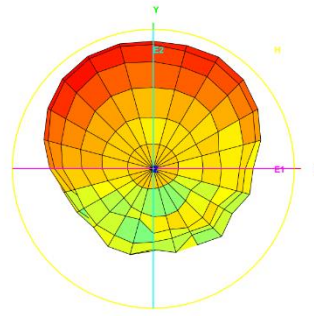

Total\_3D\_Left View\_3.3GHz

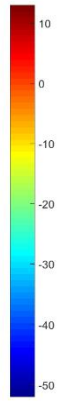
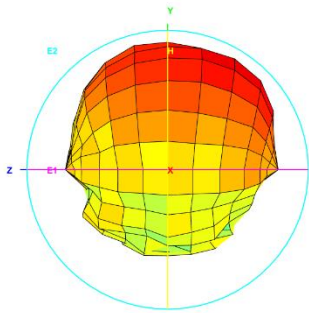

Total\_3D\_Side View 1\_3.3GHz

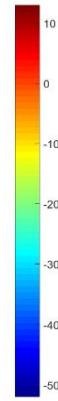
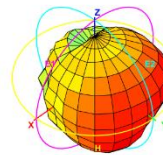

Total\_3D\_Top View\_3.6GHz

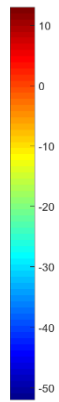
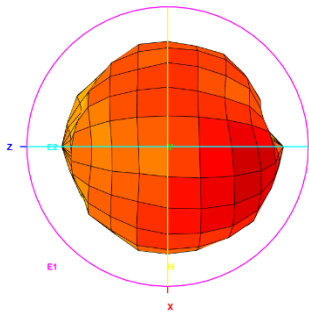

Total\_3D\_Front View\_3.6GHz

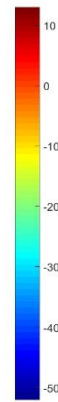
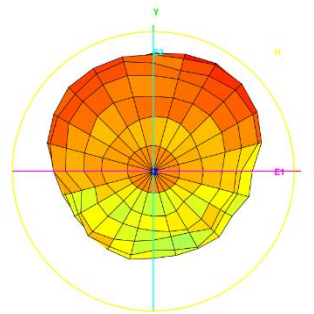

Total\_3D\_Left View\_3.6GHz

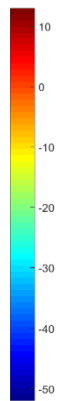
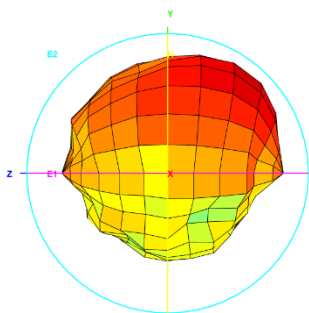

Total\_3D\_Side View 1\_3.6GHz

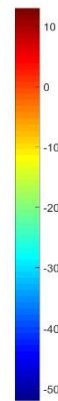
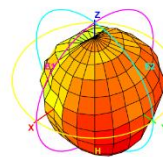

Total\_3D\_Top View\_3.8GHz

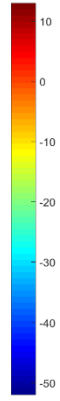
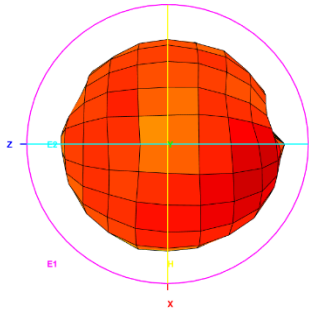

Total\_3D\_Front View\_3.8GHz

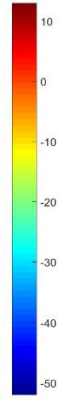
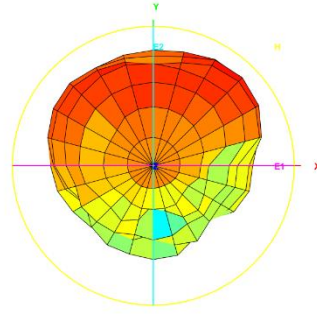

Total\_3D\_Left View\_3.8GHz

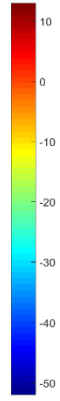
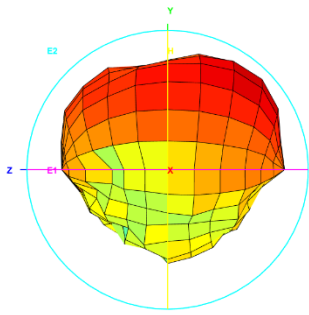

Total\_3D\_Side View 1\_3.8GHz

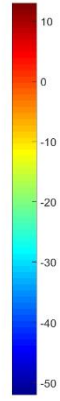
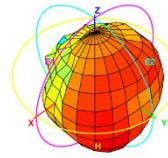

Total\_3D\_Top View\_4.4GHz

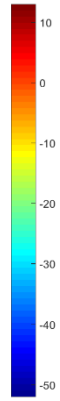
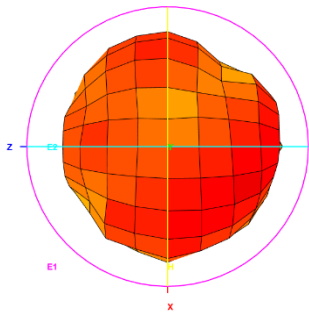

Total\_3D\_Front View\_4.4GHz

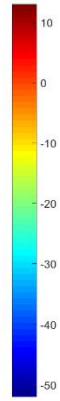
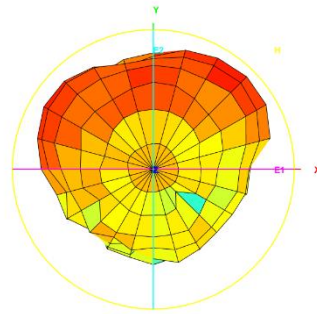

Total\_3D\_Left View\_4.4GHz

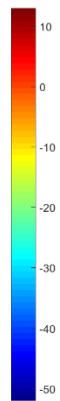
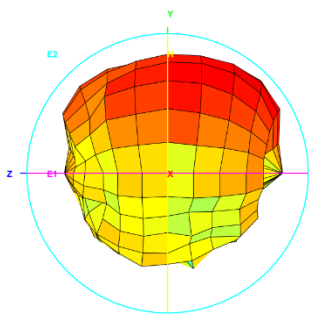

Total\_3D\_Side View 1\_4.4GHz

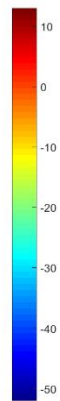
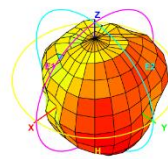

Total\_3D\_Top View\_5.15GHz

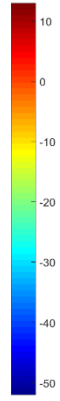
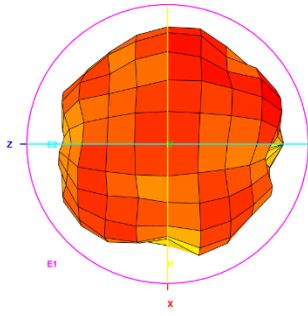

Total\_3D\_Front View\_5.15GHz

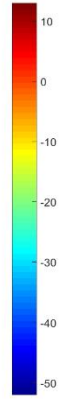
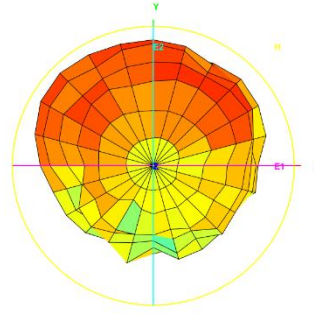

Total\_3D\_Left View\_5.15GHz

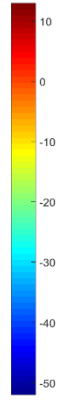
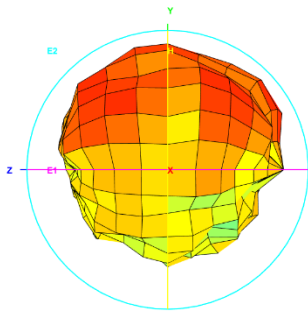

Total\_3D\_Side View 1\_5.15GHz

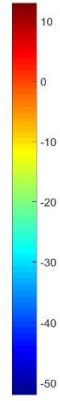
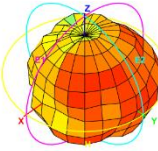

Total\_3D\_Top View\_5.5GHz

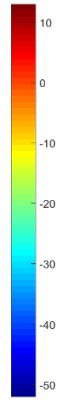
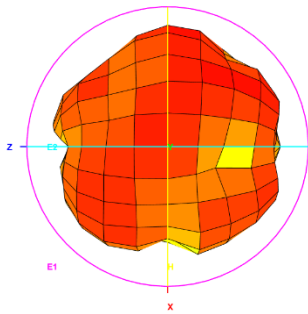

Total\_3D\_Front View\_5.5GHz

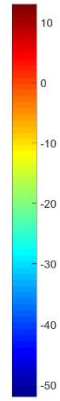
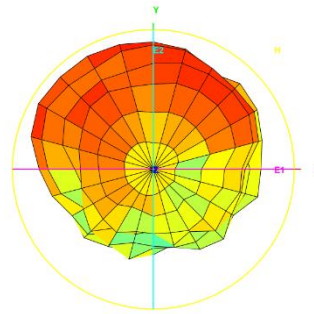

Total\_3D\_Left View\_5.5GHz

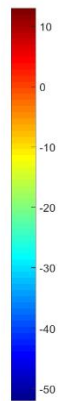
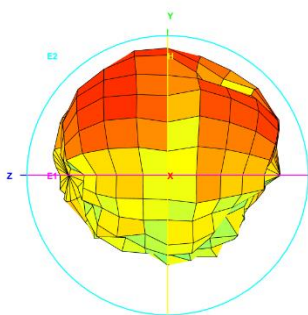

Total\_3D\_Side View 1\_5.5GHz

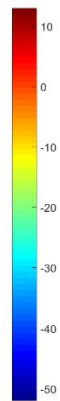
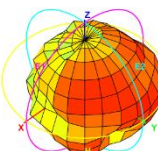

Total\_3D\_Top View\_5.8GHz

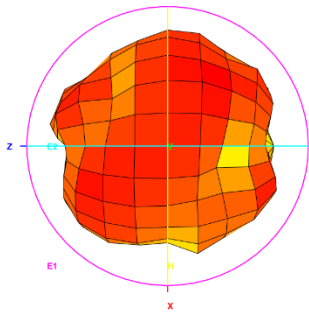

Total\_3D\_Front View\_5.8GHz

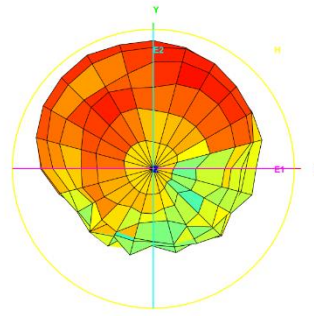

Total\_3D\_Left View\_5.8GHz

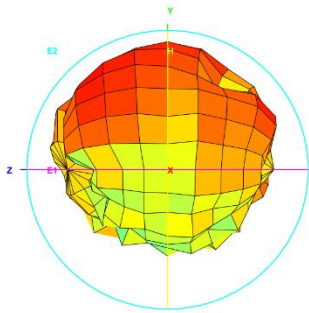

Total\_3D\_Side View 1\_5.8GHz

